

The Application of Geophysical Survey for Shallow Groundwater in Triassic weathered Meta–Sedimentary Aquifers at Sra Kaew College of Agriculture and Technology

by Ratchita Sarimanond

Groundwater Business Development Manager / Hydrogeologist

Geo and Civil Services Co., Ltd. / American Groundwater Solutions (AGS)



GEOPHYSICAL SURVEY in Groundwater work applied for Water Management

GCS

บริษัท จีโ ออนด์ ซิวิล เซอร์วิส จำกัด
Geo and Civil Services Co., Ltd.

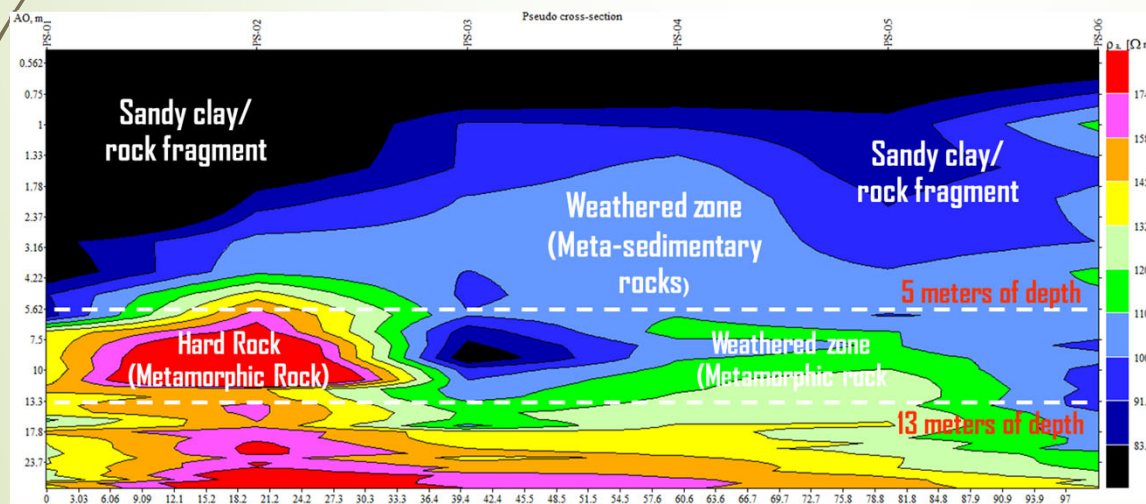

Community-based Water
Management Project under the
Royal Initiative



Agenda / Topics

1. Background and Significant
2. Objectives of the study
3. Methodology
4. The study results
5. Summary
6. Discussions and Suggestions
7. References



1. Introduction

Sra Kaew College of Agriculture and Technology, Pan Suek Sub-district, Aranyaprathet District, Sra Kaew Province, is one of the colleges facing the problem of water shortage for agricultural and participated in the community-based water management project under the royal initiative of the Deputy Minister of Education, Dr. Kalaya Sophonpanich. There are two large reservoirs within the college, which have been excavated for many years. The depth of two reservoirs is about 3-5 meters.



The project has an idea to develop two reservoirs to increase the water storage capacity by digging to expand the depth of the reservoirs to have an increased depth from the original. In order to know the information on the depth and thickness of the soil - rock layer, before planning the excavation to expand the depth of the reservoir. Therefore, the survey of geophysical data is required first.

1. Introduction

- Therefore, the project has been assigned the team to conduct a geophysical survey using the Vertical Electrical Sounding (VES) method, and then to process, analyze and interpret the data, to know the depth, thickness and type of soil-rock layers and shallow groundwater.
- Data from survey results to be used as information for planning and designing groundwater recharge wells, and determine the appropriate depth for digging groundwater recharge wells.
- This method helps to reduced the risk of the task/project before excavation of groundwater recharge to expand the depth of the reservoirs within the SCAT area.



2. Objectives of the study



1

- To apply geophysical survey for estimate the depth and thickness of the soil and rock layer and exploring shallow groundwater in weathered meta-sedimentary aquifers.

2

- To supports the community-based water management projects under the Royal Initiative of the Deputy Minister of Education, Dr. Kalaya Sophonpanich, in the Sakaew College of Agriculture and Technology (SCAT).

3. Methodology

3.1 The terrain of the survey area

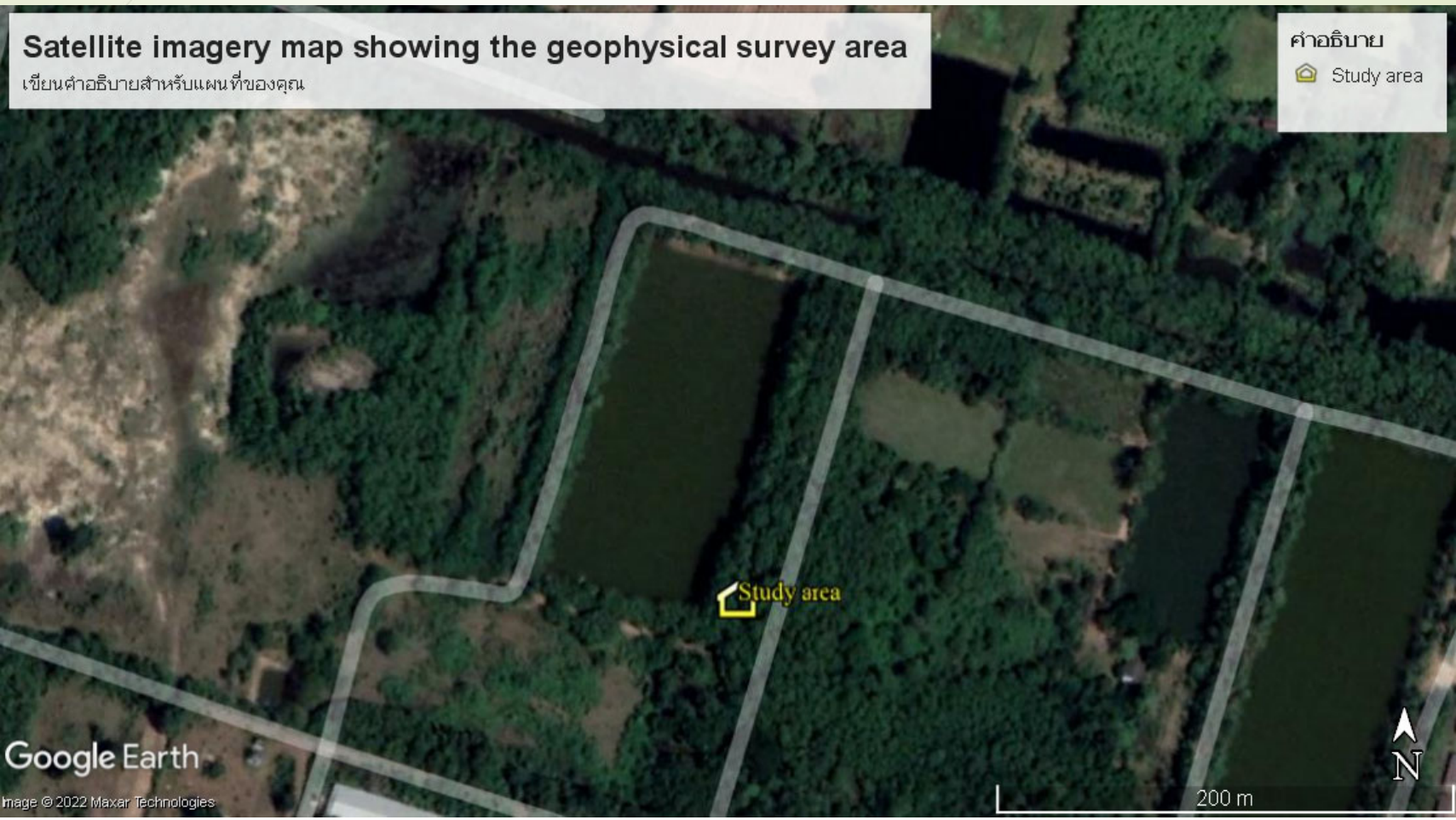

3. Methodology

3.2 Geology and Hydrogeology of the survey area



3.2 Geology and Hydrogeology of the survey area

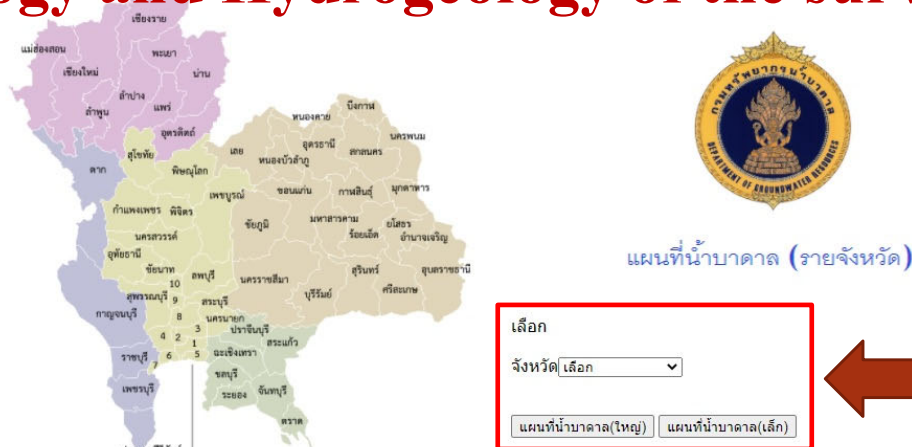

กรมทรัพยากรน้ำบาดาล

Dashboard

จำนวนบ่อ พสุธารา 111,529 บ่อ	ปริมาณน้ำ พสุธารา 890,041 (ม ³ /ชม.)	จำนวนบ่อ GCL 92,955 บ่อ	ปริมาณน้ำ GCL 8,219,607 (ม ³ /ชม.)
---------------------------------------	--	----------------------------------	--

บ่อน้ำบาดาลราชการ (พสุธารา)
*** เงื่อนไขการสืบค้นตาราง : บ่ออุปโภคบริโภค , บ่อเกษตร, สภาพน้ำ(จัด) , สภาพน้ำ(ใช้การได้)
*** คลิกที่รหัสบ่อ เพื่อดูแผนที่
📍 บ่ออุปโภค-บริโภค 📍 บ่อเกษตร

ค้นหาหมายเลขบ่อ...

Contact US

ลำดับ รหัสบ่อ สถานที่ตั้ง

ประเภท	ความลึก (เมตร)	ปริมาณน้ำ (เมตร ³ /ชม.)	ระดับน้ำปกติ (เมตร)	ระยะน้ำบาดาล (เมตร)	น้ำต้นทุน (เมตร ³ /ว.)	Ph	Fe	CL	TDS	TOS
--------	----------------	------------------------------------	---------------------	---------------------	-----------------------------------	----	----	----	-----	-----

GCS

บริษัท จี โอ แอนด์ ซีวิล เซอร์วิส จำกัด
Geo and Civil Services Co., Ltd.

Data sources: www.dgr.go.th



3.2 Geology and Hydrogeology of the survey area

Groundwater well data (www.dgr.go.th)

GCS

บริษัท จีโอ แอนด์ ซิวิล เซอร์วิส จำกัด
Geo and Civil Services Co., Ltd.

หมายเลขบ่อ	utm Easting	utm Northing	utm Zone	แผนที่	ที่อยู่	ประเภทบ่อ	สภาพน้ำ	ความลึกเจาะ (m)	ความลึกพัฒนา (m)	ปริมาณน้ำ (m ³ /hr.)	ระดับน้ำปกติ (m)	ระยะน้ำลด
5909G058	214159	1503353	48		หมู่ที่ 07 โรงเรียนบ้านหนองปรือ ตำบล ผ่านศึก อำเภอ อรัญประเทศ สระแก้ว		โซ้ได้-น้ำจืด	60.00	60.00	30.00	10.00	
6109E017	223993	1506213	48		หมู่ที่ 09 โรงเรียนนิคมสงเคราะห์ 2 ตำบล ผ่านศึก อำเภอ อรัญประเทศ สระแก้ว		โซ้ได้-น้ำจืด	84.00	84.00	4.00	4.00	
แปลงเป็น : csv						แปลงเป็น : excel	ค่าเฉลี่ย	72	72	17	19	17

General Description of Aquifers and Drilling Condition at Aranyaprathet District, Srakaew Province

Rock types	Average Depth to Aquifer (m)	Average Static Water Level (m)
Gravel, sand, clay, rock fragment	24 – 36	1 – 2
Greywacke, shale, mudstone, chert, carbonaceous shale	18 – 30 (some area 36–54)	1 – 5 (some area 5–9)
Limestone	24 – 30	1 – 3
Basalt	24 – 30	1 – 6
Granite	30 – 42	1 – 7
Andesite, rhyolite, agglomerate, tuff, basaltic andesite	12 – 26	4 – 5



3.3 The survey principle

The survey principle is release the electricity into the underground, measure the electric current (I, ampere) and measure the electric potential (V, Voltage) and calculate the resistance by using the Ohm's formula

$$R = (k) V / I$$

Where k is the geometry, the constant value of the survey position when the voltage and current are measured.

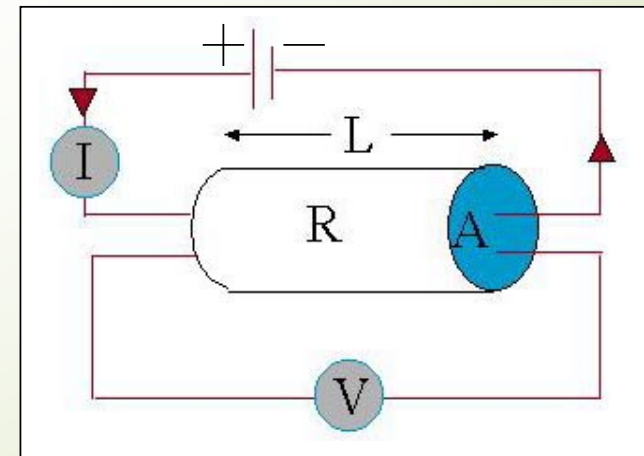

3.4 The survey method

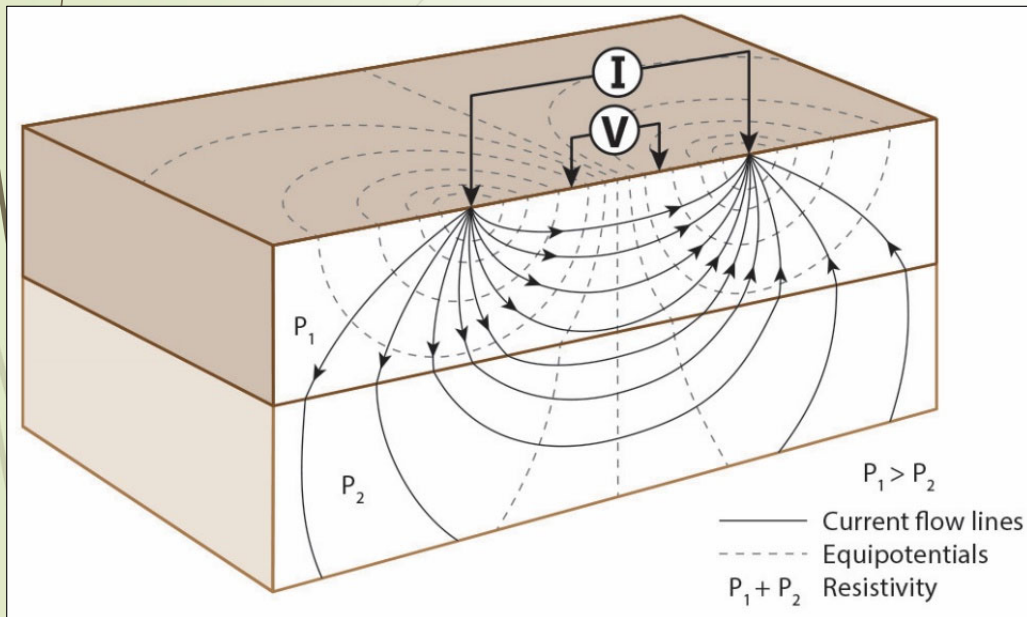

Conduct a geophysical survey by resistivity measurement to read the electrical properties of the rock-soil layer. Releasing a low frequency of direct current (DC) or alternating current (AC) to the ground with 2 electrodes, which is connected to the power sources, these two electrodes are called current electrodes (C1, C2), then measure the potential difference between any two points in the same line with the current electrode by using another pair of electrodes known as potential electrodes (P1, P2)

Resistance

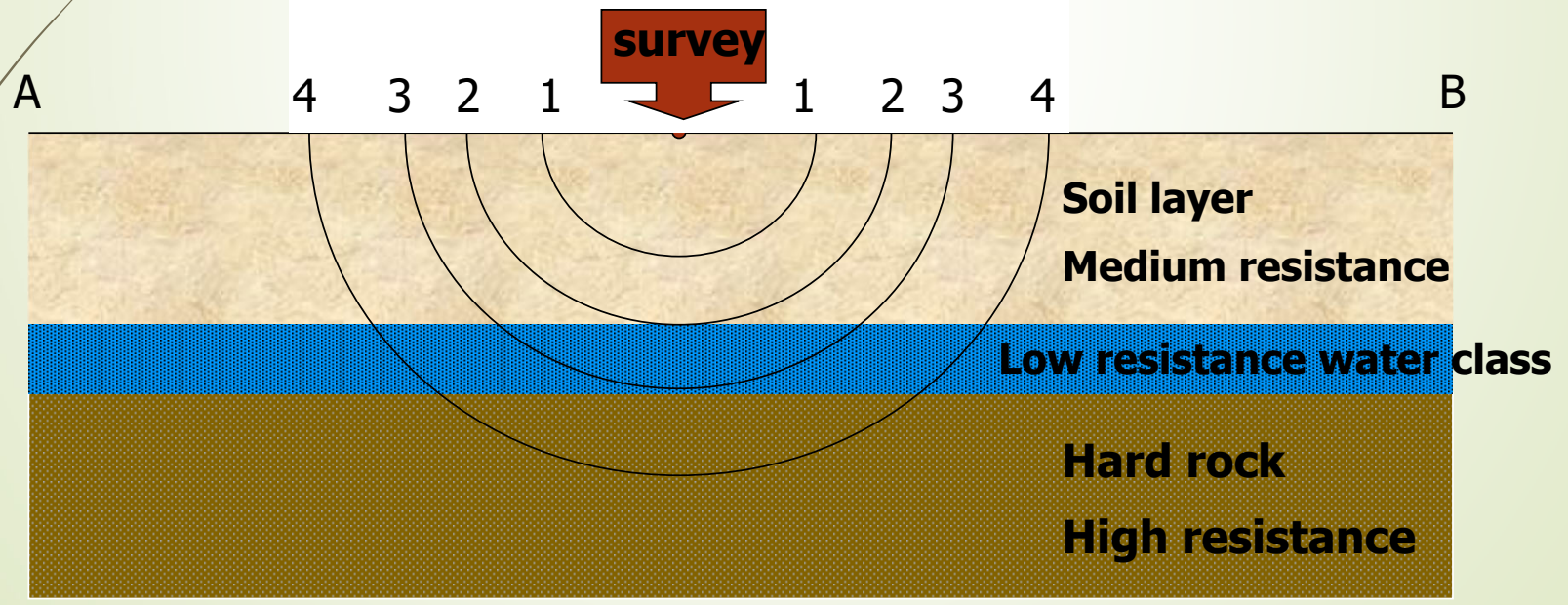
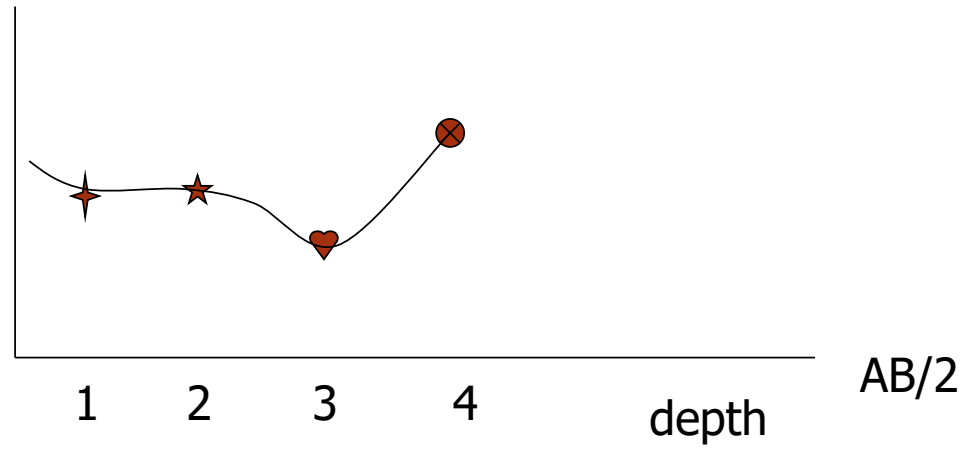

GCS

บริษัท จีโอนด์ ซีวิล เซอร์วิส จำกัด
Geo and Civil Services Co., Ltd.

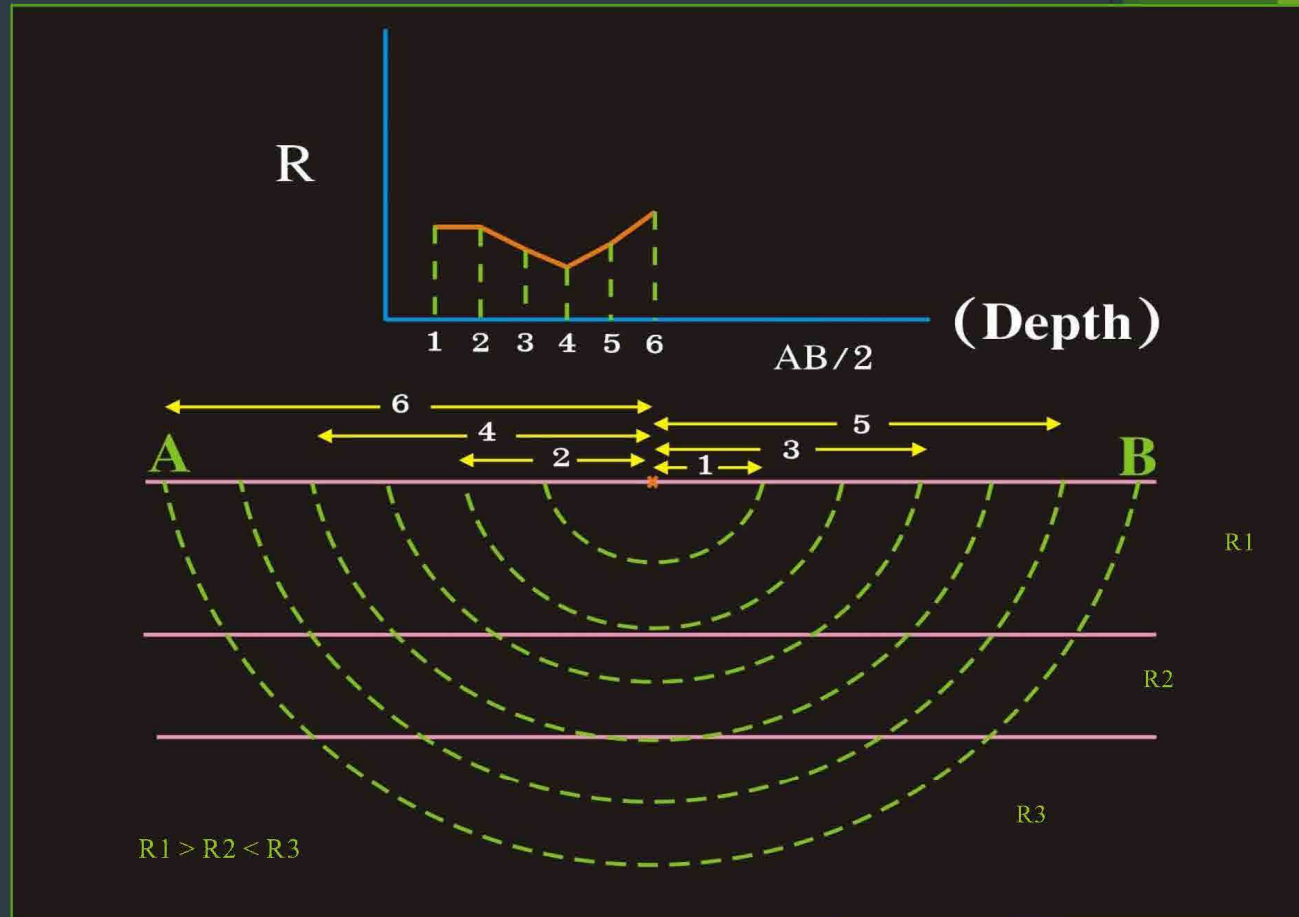

3.4 The survey method

Geophysical surveying with a SEUBSAK SS-10 instrument using a resistance measurement method. The Wenner configuration was used in the survey within the range of 120 meters long, covering the long side of the reservoir and the depth is approximately 30 meters.

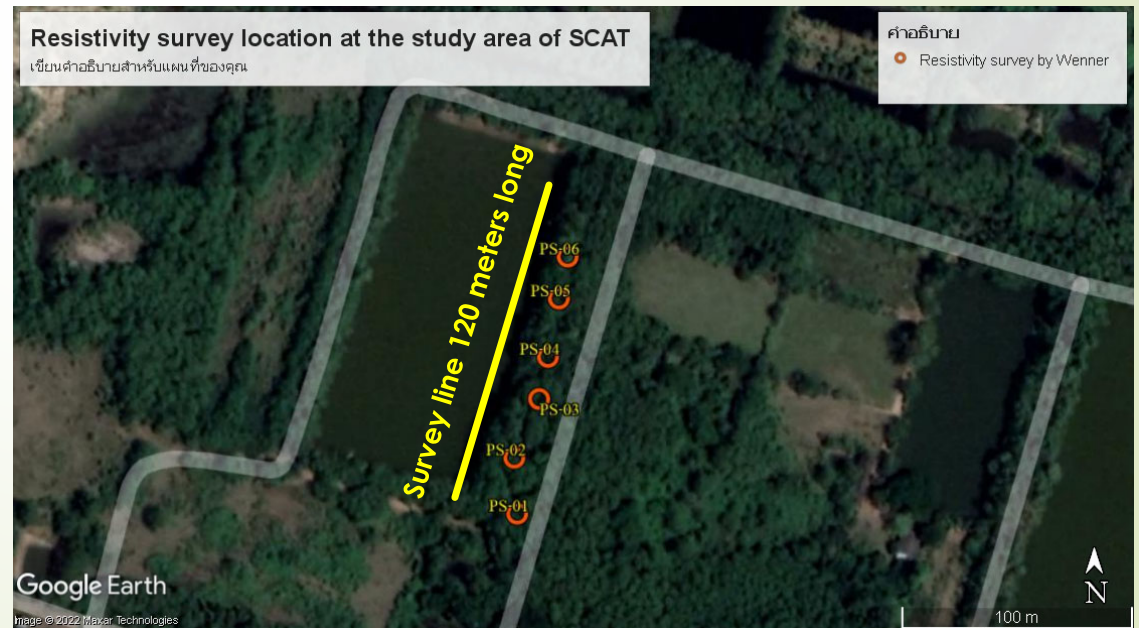
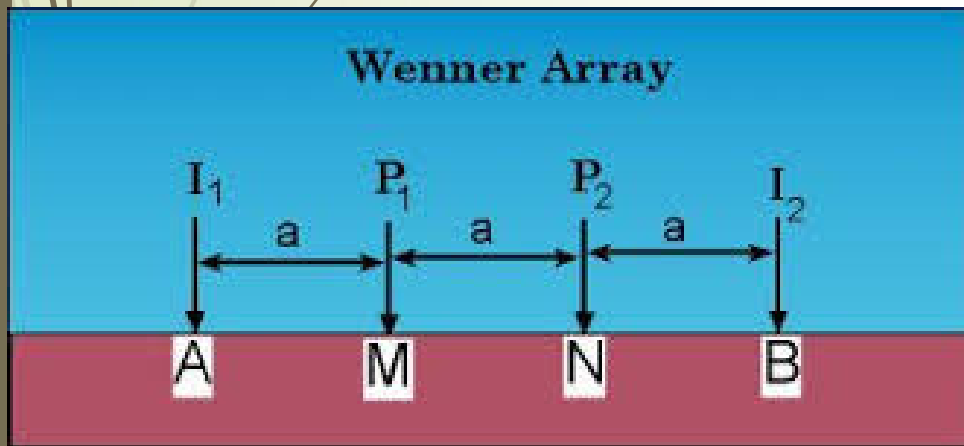

Resistivity Meter and Instrument

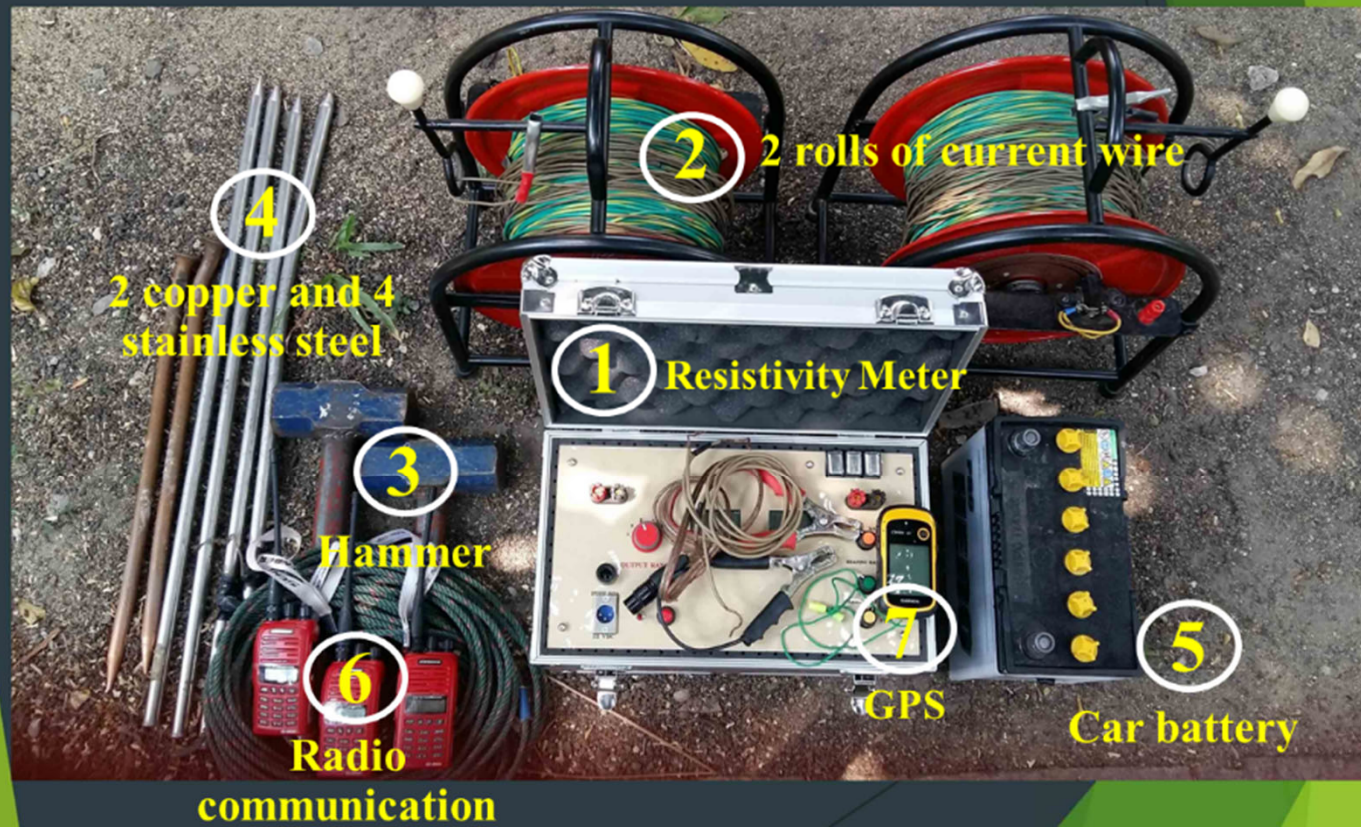

VERTICAL ELECTRICAL SOUNDING (VES)							
Wenner Configuration							
Sounding No. : PS-03						Elevation : 70 m	
Easting : 222852	Northing :	1504614			Zone :	48P	
LOCATION :							
AB/2 (m)	MN/2 (m)	K	Range	V	I	R	Pa (ohm-meter)
0.50	0.25	3.14	0.10	10.00	0.058	17.244	54.19
1.00	0.50	6.29	0.01	109.00	0.074	14.7297	92.59
1.50	0.75	9.43	0.01	54.00	0.055	9.8182	92.57
2.00	1.00	12.57	0.01	48.00	0.060	8.0000	100.57
3.00	1.50	18.86	0.01	27.00	0.049	5.5102	103.91
4.00	2.00	25.14	0.01	27.00	0.068	3.9706	99.83
5.00	2.50	31.43	0.01	19.00	0.061	3.1148	97.89
6.00	3.00	37.71	0.001	32.00	0.012	2.6667	100.57
7.00	3.50	44.00	0.01	11.00	0.056	1.9643	86.43
8.00	4.00	50.29	0.01	11.00	0.068	1.6176	81.34
9.00	4.50	56.57	0.001	75.00	0.056	1.3393	75.77
10.00	5.00	62.86	0.001	64.00	0.043	1.4884	93.55
11.00	5.50	69.14	0.001	78.00	0.054	1.4444	99.87
12.00	6.00	75.43	0.001	79.00	0.057	1.3860	104.54
13.00	6.50	81.71	0.001	70.00	0.054	1.2963	105.93
14.00	7.00	88.00	0.001	68.00	0.053	1.2830	112.91
15.00	7.50	94.29	0.001	64.00	0.051	1.2549	118.32
16.00	8.00	100.57	0.001	57.00	0.049	1.1633	116.99
17.00	8.50	106.86	0.001	67.00	0.057	1.0000	106.86
18.00	9.00	113.14	0.001	63.00	0.053	1.1887	134.49
19.00	9.50	119.43	0.001	65.00	0.057	1.1404	136.19
20.00	10.00	125.71	0.001	57.00	0.052	1.0962	137.80
21.00	10.50	132.00	0.001	57.00	0.052	1.0962	144.69
22.00	11.00	138.29	0.001	58.00	0.053	1.0943	151.33
23.00	11.50	144.57	0.001	45.00	0.046	0.9793	141.43
24.00	12.00	150.86	0.001	42.00	0.043	0.9767	147.35
25.00	12.50	157.14	0.001	49.00	0.049	1.0000	157.14
26.00	13.00	163.43	0.001	39.00	0.042	0.9286	151.76
27.00	13.50	169.71	0.001	47.00	0.047	1.0000	169.71
28.00	14.00	176.00	0.001	53.00	0.055	0.9636	169.60
29.00	14.50	182.29	0.001	40.00	0.044	0.9091	165.71
30.00	15.00	188.57	0.001	45.00	0.049	0.9184	173.18

3.5 Survey Data Collection and Recording



GCS

บริษัท จีโอสายวิสัย เซอร์วิส จำกัด
Geo and Civil Services Co., Ltd.

Page 1



3.5 Survey Data Collection and Recording along the survey line

Resistivity survey location at the study area of SCAT
เขียนคำอธิบายสำหรับแผนที่ของคุณ

คำอธิบาย
● Resistivity survey by Wenner



3.5 Survey Data Collection and Recording

GCS

บริษัท จีโ ออนด์ ซิวิล เซอร์วิส จำกัด
Geo and Civil Services Co., Ltd.



3.5 Survey Data Collection and Recording



VERTICAL ELECTRICAL SOUNDING (VES)

Wenner Configuration

Sounding No : PS-11 Elevation : 70 m

Easting : 222560 Northing : 1503742 Zone : 48P

LOCATION :

AB/2 (m)	MN/2 (m)	K	Range	V	I	R	Pa (ohm-meter)
0.50	0.25	3.14	0.10	19.00	0.371	5.1213	16.10
1.00	0.50	6.29	0.01	96.00	0.206	4.6602	29.29
1.50	0.75	9.43	0.01	71.00	0.212	3.3491	31.58
2.00	1.00	12.57	0.01	47.00	0.270	1.7407	21.88
3.00	1.50	18.86	0.01	31.00	0.282	1.0993	20.73
4.00	2.00	25.14	0.01	23.00	0.265	0.8679	21.82

3.5 Survey Data Collection and Recording

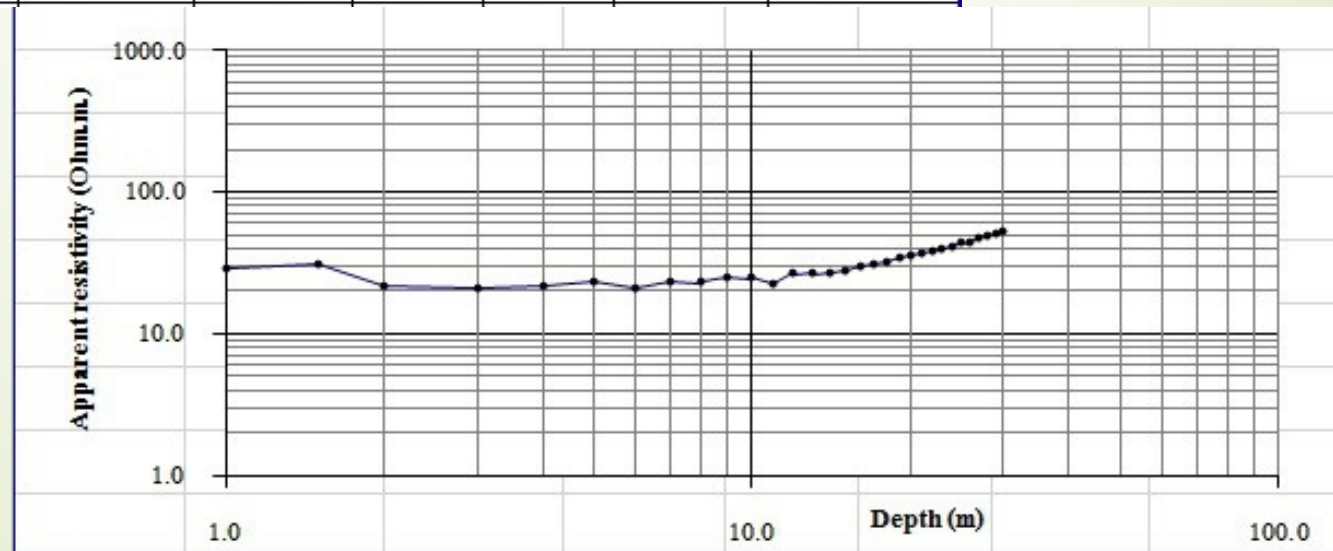



VERTICAL ELECTRICAL SOUNDING (VES)							
Wenner Configuration							
Sounding No : PS-03							Elevation : 70 m
Easting : 222852	Northing : 1504614					Zone : 48P	
LOCATION :							
AB/2 (m)	MN/2 (m)	K	Range	V	I	R	Pa (ohm-meter)
0.50	0.25	3.14	0.10	10.00	0.058	17.2414	54.19
1.00	0.50	6.29	0.01	109.00	0.074	14.7297	92.59
1.50	0.75	9.43	0.01	54.00	0.055	9.8182	92.57
2.00	1.00	12.57	0.01	48.00	0.060	8.0000	100.57
3.00	1.50	18.86	0.01	27.00	0.049	5.5102	103.91
4.00	2.00	25.14	0.01	27.00	0.068	3.9706	99.83
5.00	2.50	31.43	0.01	19.00	0.061	3.1148	97.89
6.00	3.00	37.71	0.001	32.00	0.012	2.6667	100.57
7.00	3.50	44.00	0.01	11.00	0.056	1.9643	86.43
8.00	4.00	50.29	0.01	11.00	0.068	1.6176	81.34
9.00	4.50	56.57	0.001	75.00	0.056	1.3393	75.77
10.00	5.00	62.86	0.001	64.00	0.043	1.4884	72.58
11.00	5.50	69.14	0.001	59.00	0.042	1.4957	69.57
12.00	6.00	75.43	0.001	79.00	0.057	1.3860	104.54
13.00	6.50	81.71	0.001	70.00	0.054	1.2963	105.93
14.00	7.00	88.00	0.001	68.00	0.053	1.2830	112.91
15.00	7.50	94.29	0.001	64.00	0.051	1.2549	118.32
16.00	8.00	100.57	0.001	57.00	0.049	1.1633	116.99
17.00	8.50	106.86	0.001	57.00	0.057	1.0000	106.86
18.00	9.00	113.14	0.001	63.00	0.053	1.1887	134.49
19.00	9.50	119.43	0.001	65.00	0.057	1.1404	136.19
20.00	10.00	125.71	0.001	57.00	0.052	1.0962	137.80
21.00	10.50	132.00	0.001	57.00	0.052	1.0962	144.69
22.00	11.00	138.29	0.001	58.00	0.053	1.0943	151.33
23.00	11.50	144.57	0.001	45.00	0.046	0.9783	141.43
24.00	12.00	150.86	0.001	42.00	0.043	0.9767	147.35
25.00	12.50	157.14	0.001	49.00	0.049	1.0000	157.14
26.00	13.00	163.43	0.001	39.00	0.042	0.9286	151.76
27.00	13.50	169.71	0.001	47.00	0.047	1.0000	169.71
28.00	14.00	176.00	0.001	53.00	0.055	0.9636	169.60
29.00	14.50	182.29	0.001	40.00	0.044	0.9091	165.71
30.00	15.00	188.57	0.001	45.00	0.049	0.9184	173.18

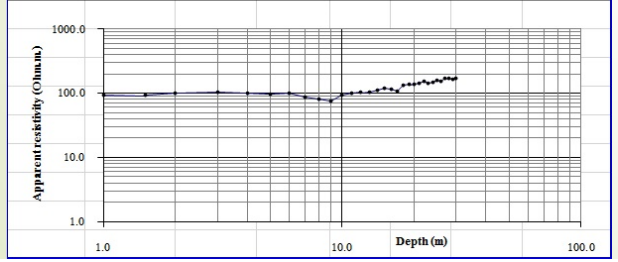

3.5 Survey Data Collection and Recording

Page 1

VERTICAL ELECTRICAL SOUNDING (VES)							
Wenner Configuration							
Sounding No : PS-11							Elevation : 70 m
Easting : 222560	Northing : 1503742					Zone : 48P	
LOCATION :							
AB/2 (m)	MN/2 (m)	K	Range	V	I	R	Pa (ohm-meter)
0.50	0.25	3.14	0.10	19.00	0.371	5.1213	16.10
1.00	0.50	6.29	0.01	96.00	0.206	4.6602	29.29
1.50	0.75	9.43	0.01	71.00	0.212	3.3491	31.58
2.00	1.00	12.57	0.01	47.00	0.270	1.7407	21.88
3.00	1.50	18.86	0.01	31.00	0.282	1.0993	20.73
4.00	2.00	25.14	0.01	23.00	0.265	0.8679	21.82
5.00	2.50	31.43	0.01	16.00	0.217	0.7373	23.17
6.00	3.00	37.71	0.01	12.00	0.213	0.5634	21.25
7.00	3.50	44.00	0.01	14.00	0.266	0.5263	23.16
8.00	4.00	50.29	0.01	13.00	0.284	0.4577	23.02
9.00	4.50	56.57	0.01	12.00	0.269	0.4461	25.24
10.00	5.00	62.86	0.01	12.00	0.205	0.3960	24.89
11.00	5.50	69.14	0.01	10.00	0.205	0.3422	22.82
12.00	6.00	75.43	0.001	100.00	0.282	0.3548	26.75
13.00	6.50	81.71	0.001	91.00	0.276	0.3297	26.94
14.00	7.00	88.00	0.001	86.00	0.280	0.3071	27.03
15.00	7.50	94.29	0.001	81.00	0.269	0.3011	28.39
16.00	8.00	100.57	0.001	82.00	0.276	0.2971	29.88
17.00	8.50	106.86	0.001	78.00	0.268	0.2910	31.10
18.00	9.00	113.14	0.001	80.00	0.279	0.2867	32.44
19.00	9.50	119.43	0.001	82.00	0.287	0.2857	34.12
20.00	10.00	125.71	0.001	91.00	0.325	0.2800	35.20
21.00	10.50	132.00	0.001	80.00	0.289	0.2768	36.54
22.00	11.00	138.29	0.001	22.00	0.078	0.2821	39.00
23.00	11.50	144.57	0.001	81.00	0.291	0.2784	40.24
24.00	12.00	150.86	0.001	78.00	0.284	0.2746	41.43
25.00	12.50	157.14	0.001	82.00	0.295	0.2780	43.68
26.00	13.00	163.43	0.001	81.00	0.294	0.2755	45.03
27.00	13.50	169.71	0.001	88.00	0.312	0.2821	47.87
28.00	14.00	176.00	0.001	81.00	0.288	0.2813	49.50
29.00	14.50	182.29	0.001	85.00	0.298	0.2852	51.99
30.00	15.00	188.57	0.001	86.00	0.306	0.2810	53.00

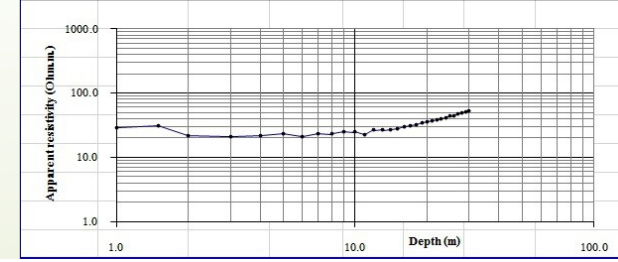

Page 1



3.6 Processing, analyzing and interpreting of survey data

Examples of interpretation of survey results for each point

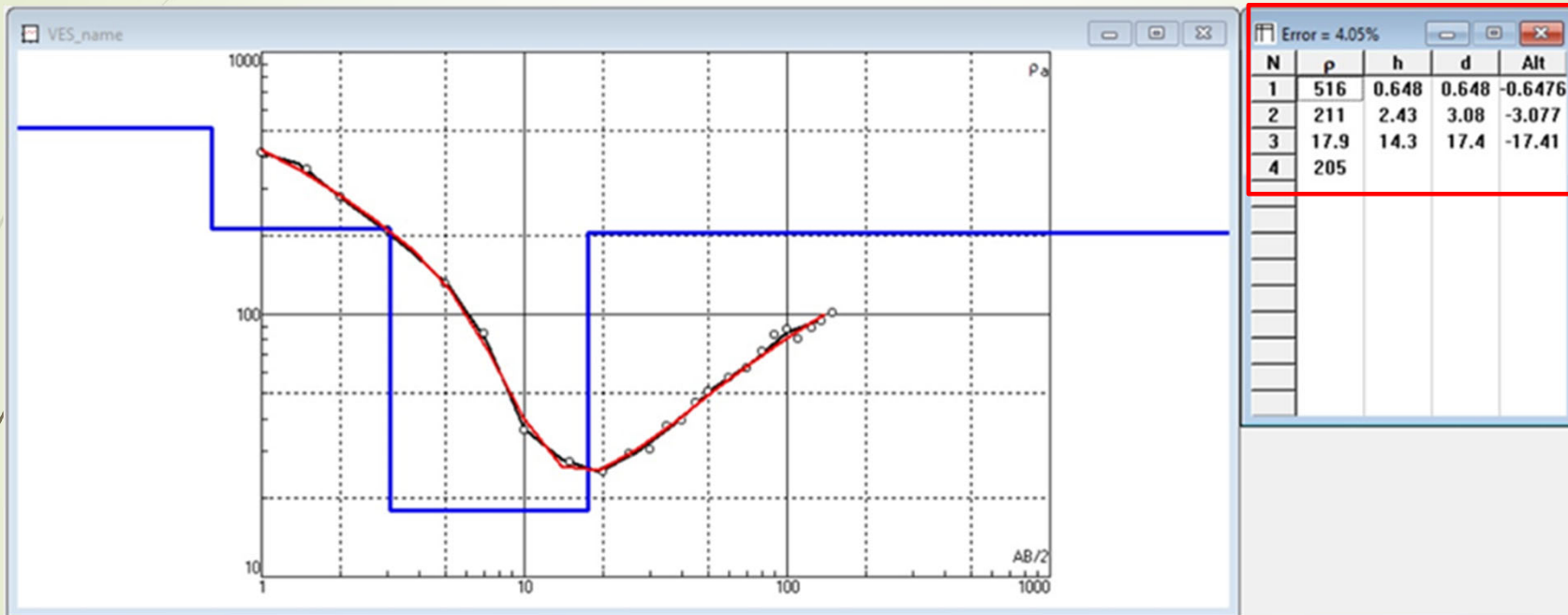

By using a computer software named IPI2Win and displayed the survey results at each point (1D Inversion)

4. The study results

4.1 Interpretation of survey results for each survey point

Survey No. PS-01		
depth (meters)	Resistance (Ohm-m)	Interpretation
0.0 - 1.2	5.40	Top soil
1.2 - 2	34.40	Sandy gravelly clay
2 - 3.56	1,041.00	Rock fragment/dry sand
3.56 - 8.91	32.90	Weathered rock (meta-sedimentary)
8.91 below	267.00	Hard rock (Metamorphic rock)
Survey No. PS-02		
depth (meters)	Resistance (Ohm-m)	Interpretation
0.0 - 1.6	64.90	Top soil
1.6 - 4.56	632.00	Rock fragment/dry sand
4.56 - 8.93	35.90	Weathered rock (meta-sedimentary)
8.93 below	1,862.00	Hard rock (Metamorphic rock)

4.2 Pseudo geophysical cross section visualization of survey results

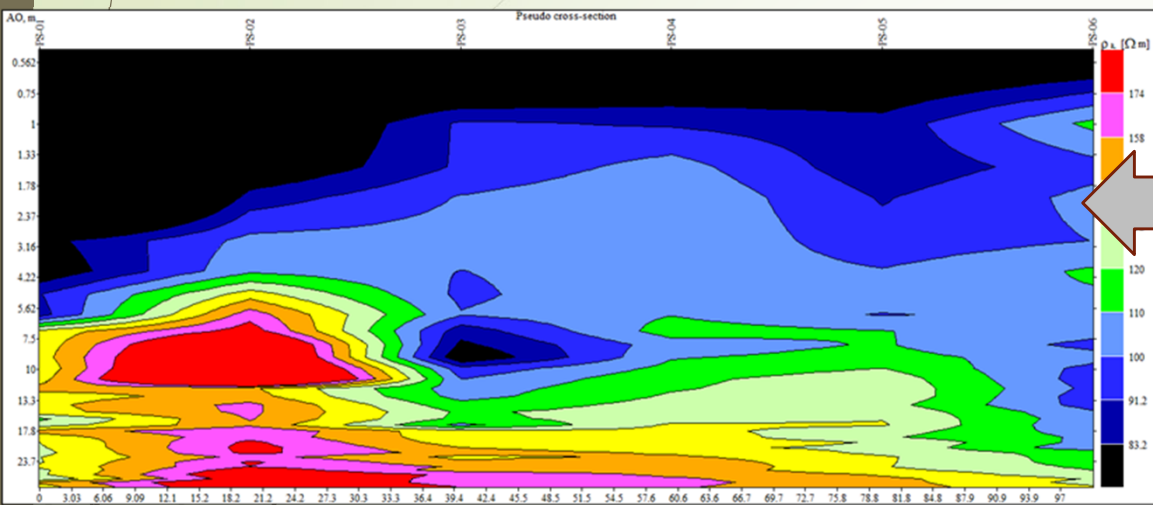

The processing results of each survey point can be displayed as a pseudo geophysical cross-section

By reference to the resistance range in different rock types

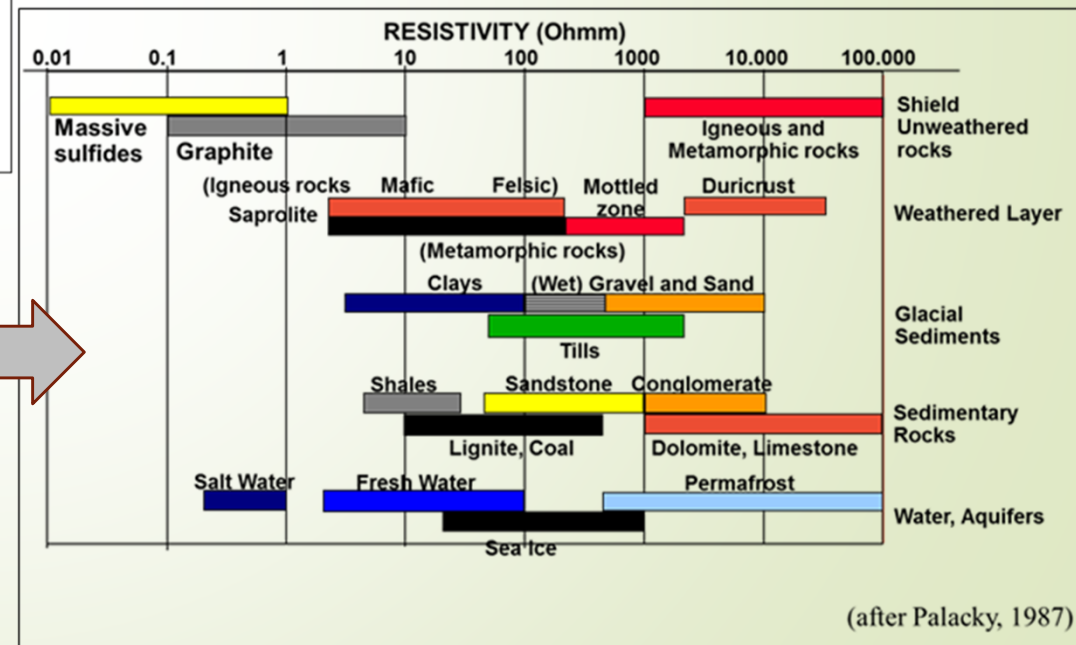

4.2 Pseudo geophysical cross section with soil-rock layer/shallow groundwater interpretation

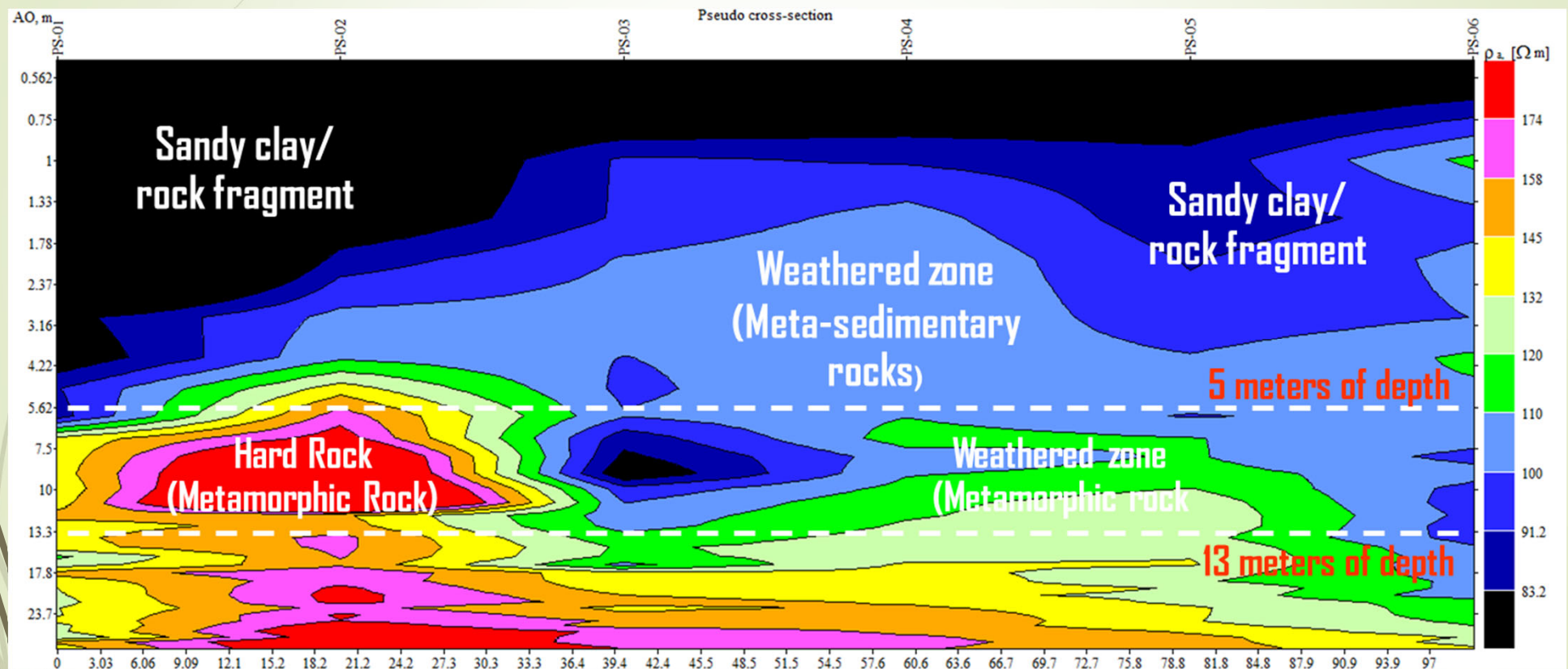

Summarized of data analysis and interpretation of resistivity survey

Resistivity survey location at the study area of SCAT

เขียนคำอธิบายสำหรับแผนที่ของคุณ

คำอธิบาย

○ Resistivity survey by Wenner

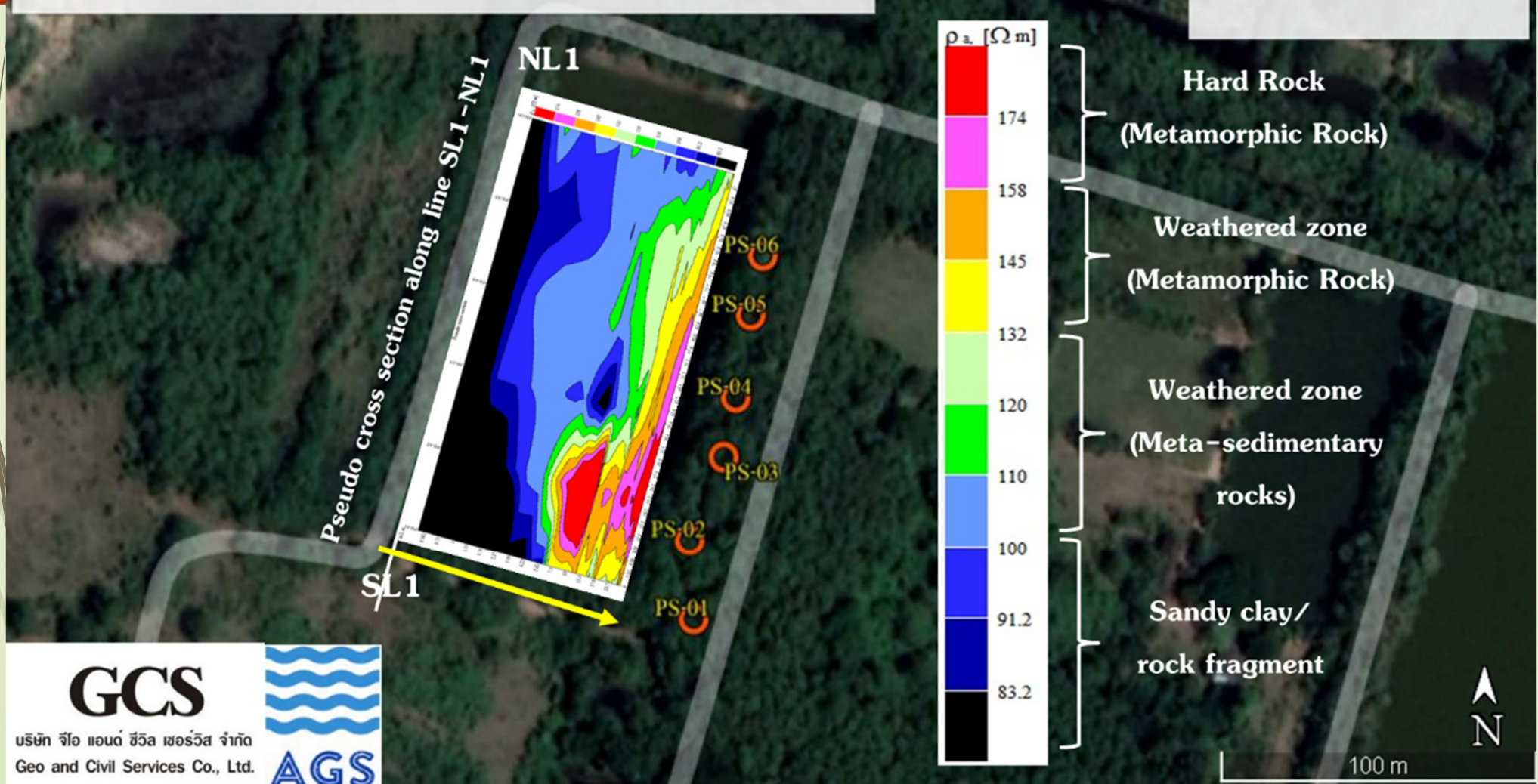

GCS

บริษัท จีโ ออนด์ ซิวิล เซอร์วิส จำกัด
Geo and Civil Services Co., Ltd.



5. Summary, Discussions and Suggestions

5.1 Summary of the survey results

Resistance range (Ohm-meter)	Color scale	Depth range (meters) that found soil-rock	Soil/rock layer/shallow groundwater
158 - 190		5 – 10 meters (some area) and 10 meters below (some area)	Hard rock (Metamorphic rock)
132 – 158		5 – 10 meters (some area) and 10 meters below (some area)	Weathered zone/Shallow groundwater (Metamorphic rock)
110 – 132		1-5 meters (some area) and 5-10 meters (some area)	Weathered zone (Meta-sedimentary rock)
70 – 110		0-1 meters (some area) and 1-5 meters (some area)	Sandy clay/ Rock fragment

Geophysical Survey Report
By Vertical Electrical Sounding (Resistivity)
of Sakaew College Agricultural and Technological

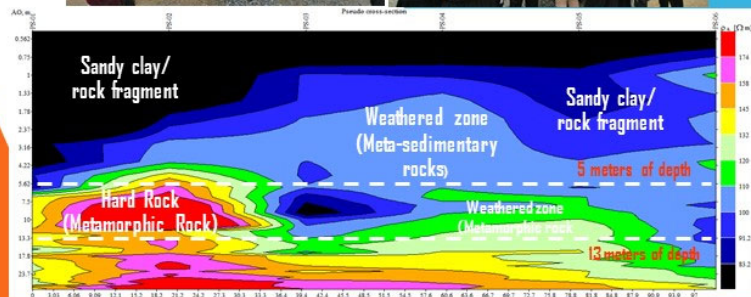

Present to

Community-based Water Management Project
under the Royal Initiative, Office of the Deputy Minister of
Education (Dr. Kanlaya Sophonpanich)

Operated by



บริษัท จีโอ แอนด์ ซิวิล เซอร์วิส จำกัด
100 ซอยพระรามเก้า 41 (ถนนเสรี 9) แขวงสวนหลวง เขตสวนหลวง
กรุงเทพมหานคร 10250 โทรศัพท์ 02-3180493, 083-4486764
อีเมลล์: gcsservices.gcs@gmail.com, www.geocivilservices.com

12 October 2020

GCS

บริษัท จีโอ แอนด์ ซิวิล เซอร์วิส จำกัด
Geo and Civil Services Co., Ltd.

The resistivity survey results recommended to improve and develop the water source by digging the additional depth of the reservoir to the shallow aquifers that are weathered zones, i.e., *from the survey point No. PS-03 to PS-04, and the survey point No. PS-05 to PS-06 at 5-7 meters of depth, and develop the additional depth at the middle part of the reservoir for the depth of 7-11 meters.*

After submitting the survey report to the College of Agriculture and Technology. The project has expanded the depth of the reservoir according to the survey results.

GCS

บริษัท จีโ ออนด์ ซิวิล เซอร์วิส จำกัด
Geo and Civil Services Co., Ltd.

Before

October, 2020



After

December, 2020



5.2 Discussions and Suggestions

1) To develop the potential of water sources be able to apply knowledge of geology and application of geophysical to assist in planning, surveying, analyzing and water management effectively. In this regard, should be considered to the appropriateness of the survey methods selection according to the context of the study area.

2) The reservoir that improved and developed, Sra Kaew College of Agriculture and Technology should be effective water usage management to achieve a balance of water resources by calculated the amount of water recharge in the reservoir and the amount of water consumption for agricultural of SCAT.

3) The developed reservoir that excavation depth to the shallow aquifer. It is considered to be a natural recharge by rainwater during the rainy season. However, SCAT should be backup water management plan in case the water level in the college and surrounding areas is changing rapidly during in a severe water shortage crisis.

4) There should be a measure the changing of groundwater both quantity and water quality, such as measurement the water level in the reservoir and groundwater wells surrounding SCAT. Water quality monitoring by regularly collecting water samples for chemical analysis.

6. References

Community-based water management project according to the royal initiative. Office of the Deputy Minister of Education (Khunying Kalaya Sophonpanich). 2020. Geophysical survey report by resistivity measurement method at Sra Kaew College of Agriculture and Technology.

Palacky, G. J. (1987). Resistivity Characteristics of Geologic Targets. In M. N. Nabighian (Ed.), Electromagnetic Methods in Applied Geophysics Theory: Tulsa, Okla (Vol. 1, pp. 53–122). Society of Exploration Geophysicists.

<http://app.dgr.go.th/newpasutara/xml/Krabi.files/show3.php>

<http://app.dgr.go.th/newpasutara/xml/Krabi.files/show.php>

http://www.dmr.go.th/download/pdf/Central_East/sakaeo.pdf

<https://www.easypower.com/resources/article/soil-resistivity-information-and-field-testing>



กรมทรัพยากรธรณี
Department of Mineral Resources

